

RADICAL PLASMA SOURCE (REMOTE PLASMA SOURCE) - MA3000C-463BB

Categories: Plasma components

Outline Dimensions (mm(inch))

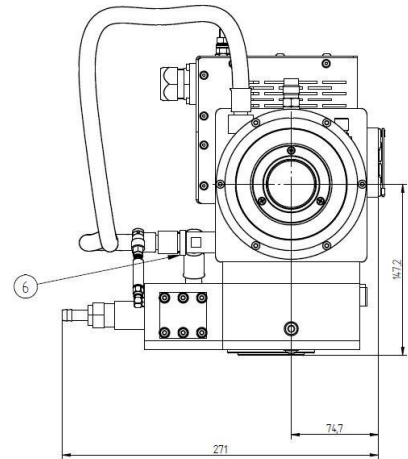

BILDERGALERIE

Outline Dimensions (mm(inch))

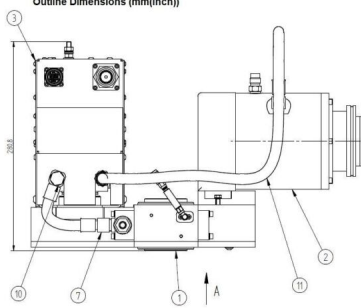

Outline Dimensions (mm(inch))

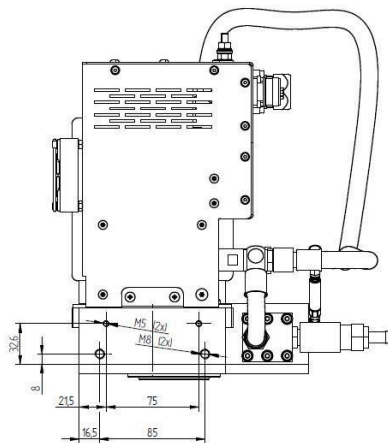

ADDITIONAL INFORMATION

Typ	Radical plasma source (Remote Plasma Source)
Process	Etching & Deposition
Output Connection Type	
Dielectric material	Ceramics
Mains voltage nominal [V]	230 / 208
Output Power [W]	3000
Frequency [MHz]	2450