

RADICAL PLASMA SOURCE (REMOTE PLASMA SOURCE) - MA2000C-133BB

Catégorie: Composants plasma

Outline Dimensions (mm(inch))

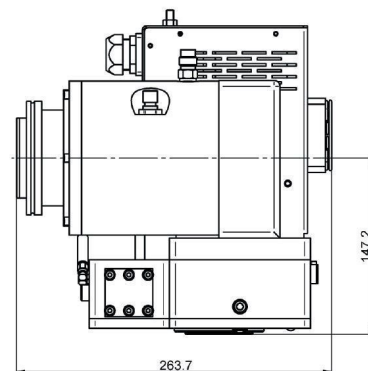

BILDERGALERIE

Outline Dimensions (mm(inch))

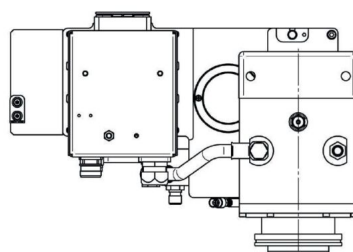
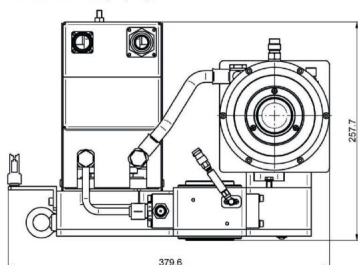

Outline Dimensions (mm(inch))

INFORMATION ADDITIONNELLE

Tapez	Source plasma à radicaux (Remote plasma Source)
Processus	Gravure et Dépôt (Revêtement)
Type de connexion de sortie	
Matériau Diélectrique	Céramique
Tension d'alimentation Nominal [V]	230 / 208
Puissance de sortie [W]	2000
Fréquence [MHz]	2450