

# RADICAL PLASMA SOURCE (REMOTE PLASMA SOURCE) - MA3000C-463BB

Catégorie: Composants plasma

Outline Dimensions (mm(inch))

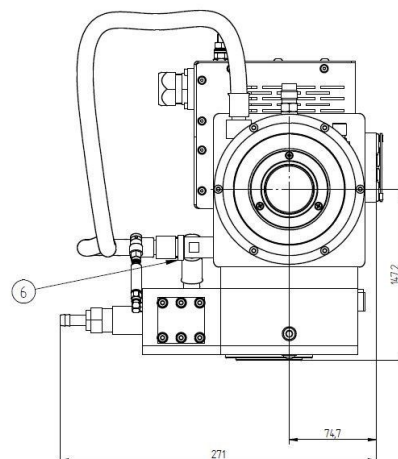

## BILDERGALERIE

Outline Dimensions (mm(inch))

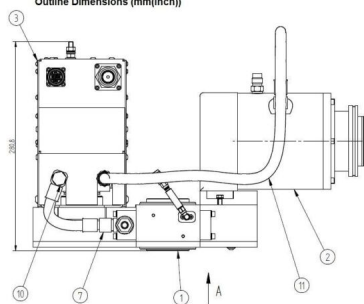

Outline Dimensions (mm(inch))

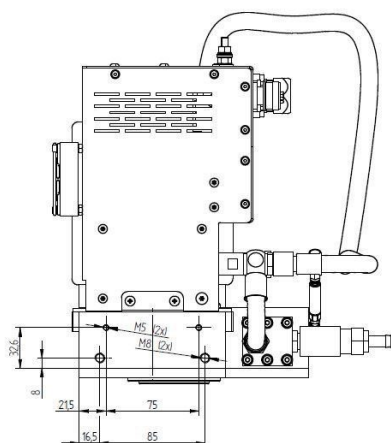

## INFORMATION ADDITIONNELLE

<b>Tapez</b>	Source plasma à radicaux (Remote plasma Source)
<b>Processus</b>	Gravure et Dépôt (Revêtement)
<b>Type de connexion de sortie</b>	
<b>Matériau Diélectrique</b>	Céramique
<b>Tension d'alimentation Nominal [V]</b>	230 / 208
<b>Puissance de sortie [W]</b>	3000
<b>Fréquence [MHz]</b>	2450