

RADIKALQUELLE (REMOTE-PLASMA-QUELLE) - MA3000C-283BB

Kategorie: Plasma-Komponenten

Outline Dimensions (mm(inch))

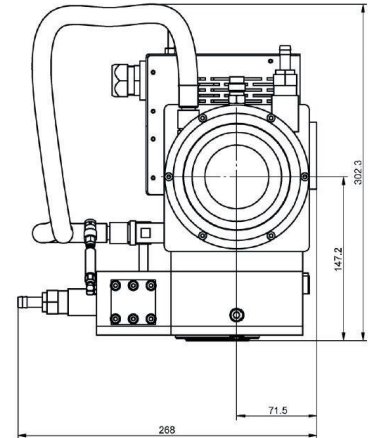

BILDERGALERIE

Outline Dimensions (mm(inch))

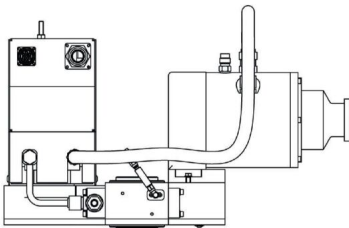

Outline Dimensions (mm(inch))

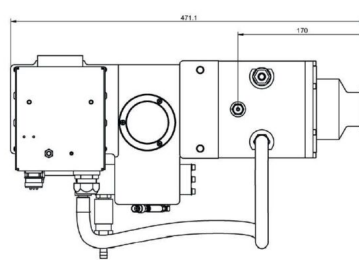

ZUSÄTZLICHE INFORMATIONEN

Art	Radikalquelle (Remote-Plasma-Quelle)
Prozess	Ätzen & Abscheiden (Beschichten)
Auskoppelgröße	KF40
Material Dielektrikum	Keramik
Netzspannung Nominal [V]	230 / 208
Leistung [W]	3000
Frequenz [MHz]	2450