

MAGNETRON - MB2727A-141DC

Category: Magnetrons

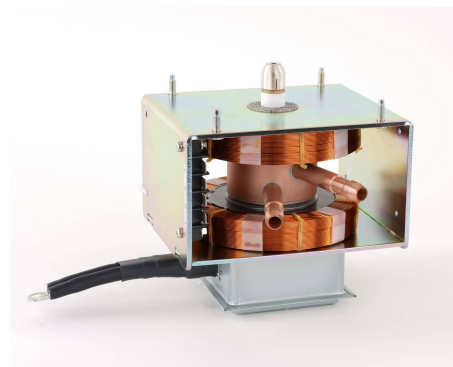

BILDERGALERIE

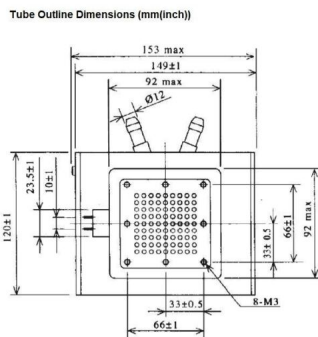
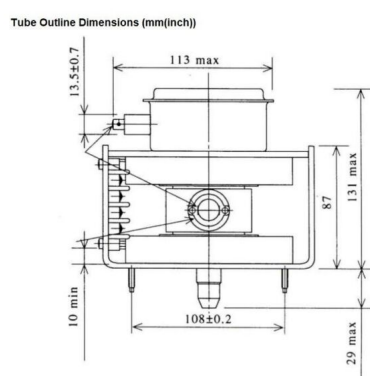
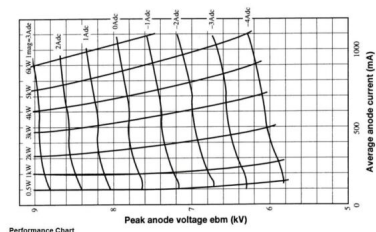

ADDITIONAL INFORMATION

Typ	Magnetron
OEM Item Number	MB2727A-141DC
Output Power CW [W]	6000
Frequency [MHz]	2450
ISM Band	S-Band
Cooling	water-cooled
Orientation of HV and cooling connectors	90°
Fastening / Studs	2x M5 Bolt (Studs)
Orientation HV to fastening	90°
Magnet	E-Magnet + Packaged magnet
Cooling Connector Type	Hose Nipple Ø12 mm
Temperature sensor	50 °C (122 °F)