

RADICAL PLASMA SOURCE (REMOTE PLASMA SOURCE) - MA2000C-223BB

Category: Plasma components

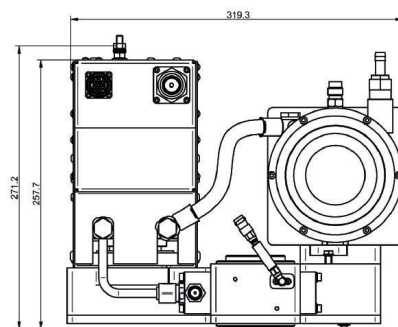

Outline Dimensions (mm(inch))

BILDERGALERIE

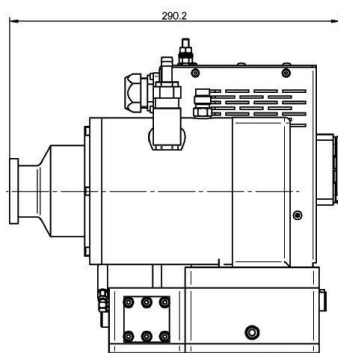

Outline Dimensions (mm(inch))

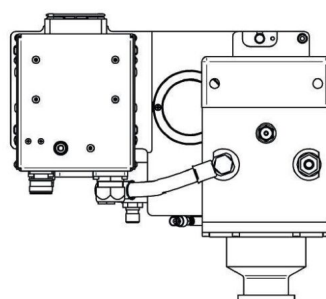

Outline Dimensions (mm(inch))

ADDITIONAL INFORMATION

Typ	Radical plasma source (Remote Plasma Source)
Process	Etching & Deposition
Output Connection Type	
Dielectric material	Ceramics
Mains voltage nominal [V]	230 / 208
Output Power CW [W]	2000
Frequency [MHz]	2450