

# RADIKALQUELLE (REMOTE-PLASMA-QUELLE) - MA3000C-463BB

类别: 等离子组件

Outline Dimensions (mm(inch))

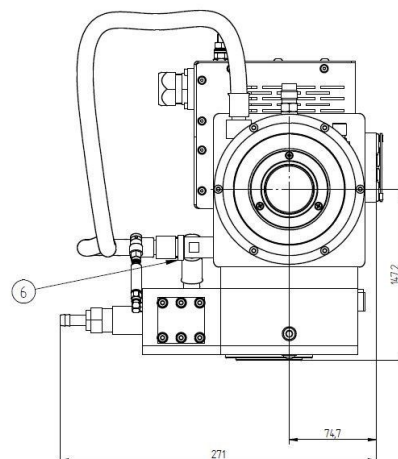

## BILDERGALERIE

Outline Dimensions (mm(inch))

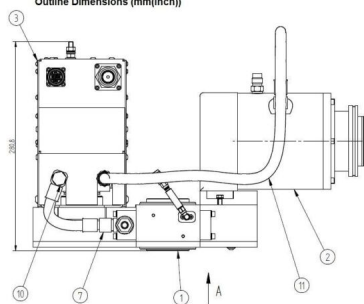

Outline Dimensions (mm(inch))

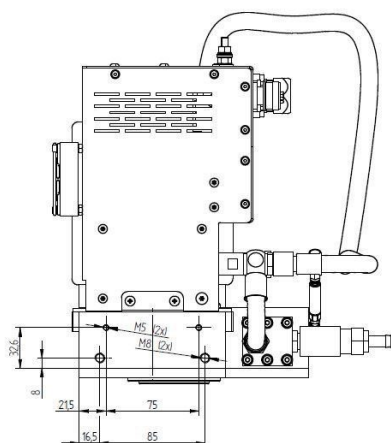

## 附加信息

设备型号	自由基等离子源 (远程等离子源)
流程	蚀刻和沉积 (涂层)
输出连接方式	ISO-K63
介电材料	陶瓷
供电电压[V]	230 / 208
输出功率 [W]	3000
Frequency [MHz]	2450